

Data Sheet

Polygard[®]-CN Filters

Versatile pleated filters for the clarification and prefiltration of process fluids

Polygard[®]-CN products are nominally rated filters designed for particle removal applications in liquids and gases. The pleated structure of Polygard[®]-CN filter media minimizes pressure differentials during the filtration process, and the all-polypropylene construction of these filters conveys low levels of extractables and broad chemical compatibility. Downstream filter performance is enhanced due to efficient particle and microorganism reduction.

Benefits

- Nominal particle retention rating
- Low pressure drop
- Low extractables levels
- Broad range of micron ratings to match an array of particle removal applications
- Designed for rigorous process conditions and broad chemical compatibility
- Ideal for designing scalable solutions from bench top to full-scale manufacturing



Regulatory Compliance

Polygard®-CN filters are designed, developed, and manufactured in accordance with a Quality Management System approved by an accredited registering body to an ISO® 9000 Quality Systems Standard and are shipped with a Certificate of Quality. Each Opticap® XL capsule and cartridge filter is supported by a Validation Guide for compliance with regulatory requirements. For traceability and easy identification, each filter is marked with identifying characteristics.

Multiple Formats Available

Polygard®-CN filters are available in three formats, seven pore sizes, and multiple configurations that vary by filtration area and the type of inlet/outlet connection.

Media Types

Polygard®-CN (nominal)

- 0.3 µm
- 0.6 µm
- 1.2 µm
- 2.5 µm
- 5.0 µm
- 10.0 µm
- 30.0 µm

Filter Formats

- OptiScale® small-scale disposable capsule filters
- Opticap® XL disposable capsule filters
- Cartridge filters



OptiScale® Process Development Screening Tool

OptiScale® disposable capsule filters with Polygard®-CN media provide a convenient small-volume option for process screening and scaling. These "drop in" filters are ideal for evaluating biopharmaceuticals. OptiScale® capsule filters offer speed-to-market strategies for efficiently developing compounds and biotherapeutics.

The OptiScale® disposable capsule is ideally suited for process development and screening. OptiScale® capsules are faster and easier to set up than conventional 47 mm discs.

Opticap® XL Disposable Capsule Filters

Opticap® XL disposable capsule filters with Polygard®-CN media are available in two filter sizes.

The patented Opticap® XL capsule design allows unparalleled thermal and hydraulic stress resistance in a disposable filter, resulting in reliability, high confidence in the sterility process and improved cleanliness. The unique capsule design with pleated Polygard®-CN media minimizes hold-up volume and reduces production losses.

Convenient and Easy to Use

Opticap® XL capsule filters eliminate the time and the expense associated with assembling, cleaning, and validating stainless steel housings. Adjustable, easy-to-turn, upstream vents and drain valves with o-ring seals and hose barb connections allow for easy process control. Other ease-of-use features include flow directional arrows and ribbed edges for easy gripping even with gloved hands.

The Right Size

A range of filter sizes is available to fit all of your application needs, and to allow easy scale-up of your small volume filtration steps to larger, full-scale filtration processes.

The Right Connections

Self-contained and disposable, Opticap® XL capsule filters are supplied with a choice of inlet and outlet connections to optimize your filtration process, including sanitary flanges which enables a higher flow rate, fractional sanitary flanges, and hose barbs.

Cartridge Filters

Polygard®-CN cartridge filters provide high throughput and minimal differential pressure. Cartridges are robust, strong, resilient and are designed to withstand multiple steam-in-place cycles.

A full range of filter sizes is available to suit your application requirements. A variety of connection options are offered for easy adaptation to existing housings.



OptiScale® Filters



Opticap® XL Filters



Cartridge Filters

Specifications

OptiScale®			
Nominal Dimensions			
Inlet/outlet:	Flange/hose barb	Flange/flange	Hose barb/hose barb
Maximum length:	82 mm (3.24 in.)	74 mm (2.91 in.)	94 mm (3.70 in.)
Diameter:	69 mm (2.75 in.)	69 mm (2.75 in.)	69 mm (2.75 in.)
Weight:	2.3 oz (67 g)	2.3 oz (67 g)	2.3 oz (67 g)
Filtration Area	13.8 cm ²		
Materials of Construction			
Filter media:	Polypropylene		
Structural components:	Polycarbonate		
Vent cap:	PVDF		
Internal seal rings:	fluoroelastomers		
Housing Vent	Adjustable vent with male luer and female Luer-Lok™ connections on inlet side of device.		
Maximum Inlet Pressure	5.5 bar (80 psi) at 25 °C		
Oxidizable Substances	Capsules meet the requirements of the USP Oxidizable Substance for Sterile Water for Filtration Test after a water flush of ≤ 100 mL.		
Sterilization by Autoclave	May be autoclaved for 3 cycles of 60 minutes at 126 °C.		
Good Manufacturing Practices	These products are manufactured in a facility which adheres to FDA Good Manufacturing Practices.		
Component Material Toxicity	Component materials were tested and meet the criteria of the USP <88> Reactivity Test for Class VI Plastics. This product is non-toxic per the USP <88> Safety Test.		
Indirect Food Additive	All component materials meet the FDA Indirect Food Additive requirements cited in 21 CFR 177-182.		

Specifications (continued)

	Opticap® XL 5	Opticap® XL 10	Cartridge Filters 4-inch	Per 10-inch
Nominal Dimensions				
Maximum length:	21.6 cm (8.5 in.)	33.5 cm (13.2 in.)	–	–
Diameter:	10.7 cm (4.2 in.)	10.7 cm (4.2 in.)	71 mm (2.75 in.)	70 mm (2.75 in.)
Filtration Area	0.18 m ² (1.9 ft ²)	0.42 m ² (4.5 ft ²)	0.18 m ² (1.9 ft ²)	0.42 m ² (4.5 ft ²)
Materials of Construction				
Filter media:	Polypropylene		Polypropylene	
Supports:	Polypropylene		Polypropylene	
Structural components:	Polypropylene		Polypropylene	
Vent o-rings:	Silicone		–	
O-rings:	–		Ethylene Propylene (Std)	
Vent/Drain	¼ in. hose barb with double o-ring seal		–	
Maximum Inlet Pressure	5.5 bar (80 psi) at 25 °C 2.8 bar (40 psi) at 60 °C 1.0 bar (15 psi) at 80 °C		–	–
Maximum Operating Temperature	–		80 °C continuous	
Maximum Differential Pressure				
Forward:	4.8 bar (70 psid) at 20 °C			
NVR Gravimetric Extractables	After autoclaving and a 24 hour soak in ASTM® Type 1 reagent grade water at controlled room temperature:			
	≤25 mg	≤55 mg	–	≤50 mg
Bacterial Endotoxin	Aqueous extraction contains <0.5 EU/mL as determined by the Limulus Amebocyte Lysate (LAL) Test.			
Oxidizable Substances	Capsules meet the requirements of the USP Oxidizable Substances Test after a water flush of:			
	≤2000 mL	≤5000 mL	–	5000 mL
Sterilization by Autoclave	May be autoclaved for 3 cycles of 30 minutes at 126 °C. (Cannot be steam sterilized in-line)		May be autoclaved for 10 cycles of 30 minutes at 126 °C or steam sterilized for 10 cycles for 30 minutes at 126 °C or hot water sanitized at 80 °C maximum for 30 minutes.	
Component Material Toxicity	Component materials were tested and meet the criteria of the USP <88> Reactivity Test for Class VI Plastics. Polygard®-CN filters meet the requirements of the USP <88> Safety Test utilizing a 0.9% sodium chloride extraction.			
Indirect Food Additive	All component materials meet the FDA Indirect Food Additive requirements cited in 21 CFR 177-182.			
European Pressure Equipment Directive	We certify that this product complies with the European Pressure Equipment Directive, 97/23/EC of 29 May 1997. This product has been classified under Article 3 § 3 of the Pressure Vessel Directive. It has been designed and manufactured in accordance with sound engineering practice to ensure safe use. In compliance with Article 3 § 3 of this Pressure Equipment Directive, this product does not bear the CE mark.		–	–

Typical Clean Water Flow Rates

Opticap® XL 5 Capsule with Polygard®-CN Media – 0.3 µm Nominal (KN03)

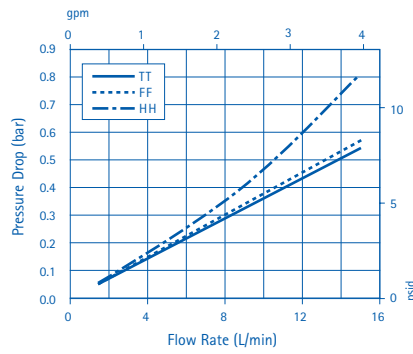

Opticap® XL 5 Capsule with Polygard®-CN Media – 5.0 µm Nominal (KN50)

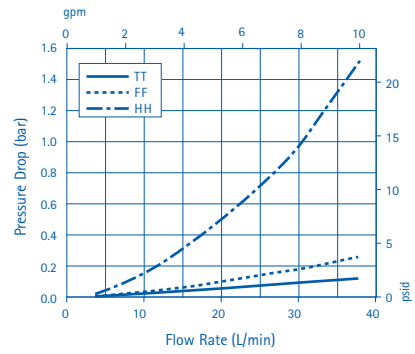

Opticap® XL 10 Capsule with Polygard®-CN Media – 0.3 µm Nominal (KN03)

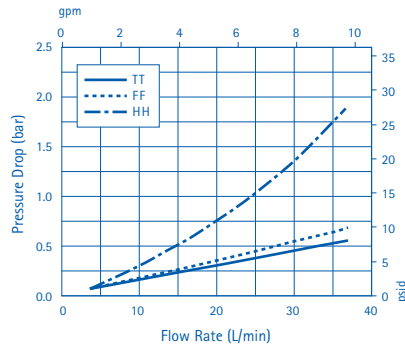

Opticap® XL 10 Capsule with Polygard®-CN Media – 5.0 µm Nominal (KN50)

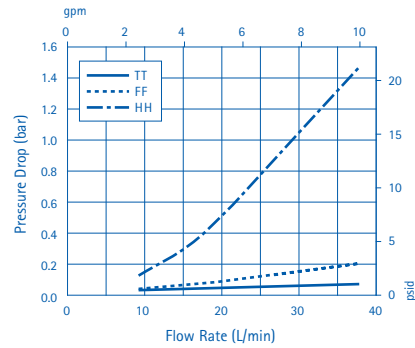

Opticap® XL Legends Refer to Connection Type

- TT = 38 mm (1½ in.)
Sanitary Flange Inlet
and Outlet
- FF = 19 mm (¾ in.)
Sanitary Flange Inlet
and Outlet
- HH = 14 mm (⅝ in.) Hose
Barb Inlet and Outlet

Cartridge Legend Refers to Pore Size

- CN03 = 0.3 µm
- CN06 = 0.6 µm
- CN12 = 1.2 µm
- CN25 = 2.5 µm
- CN50 = 5.0 µm

Cartridge Filter with Polygard®-CN Media – 10-inch

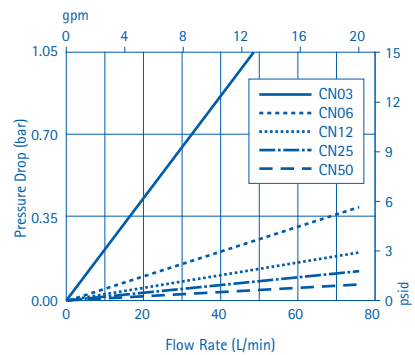

Ordering Information

OptiScale® Capsule Filters

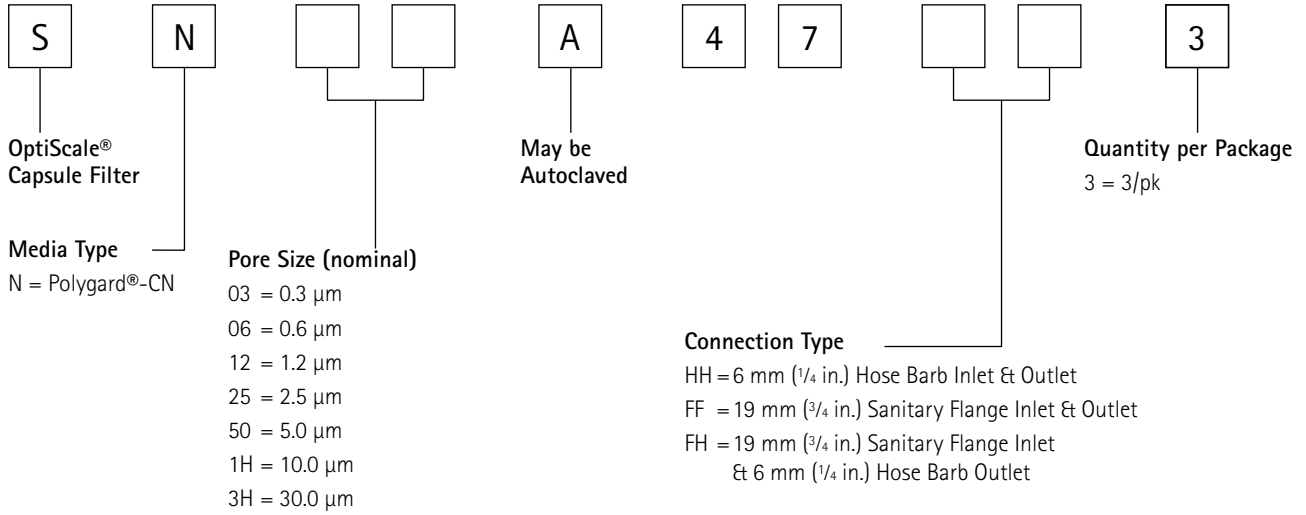

Opticap® XL Capsule Filters

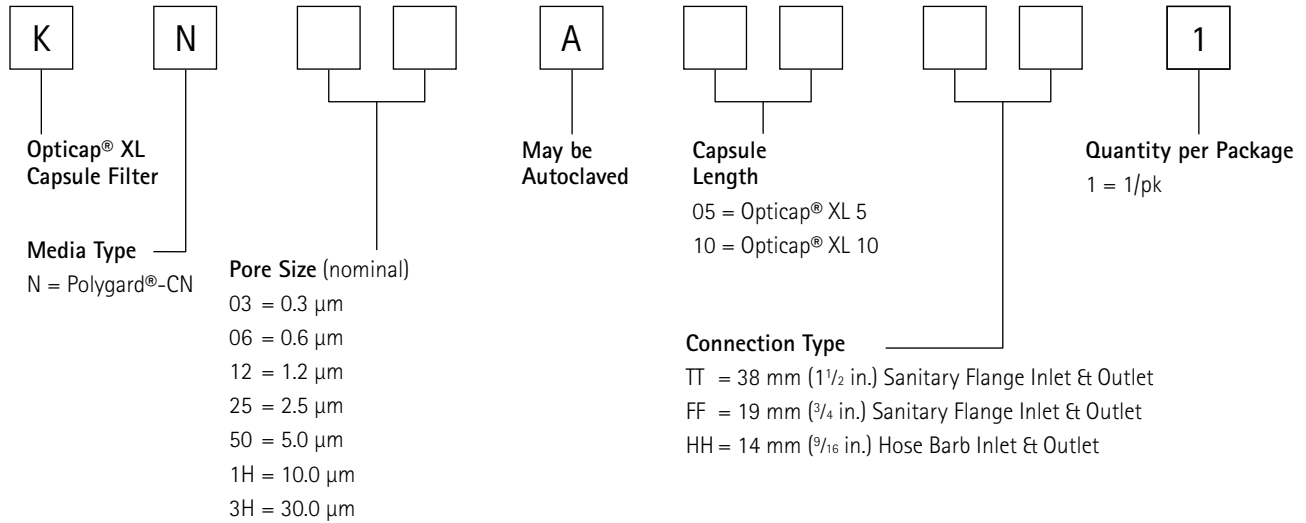

Ordering Information

Cartridge Filters

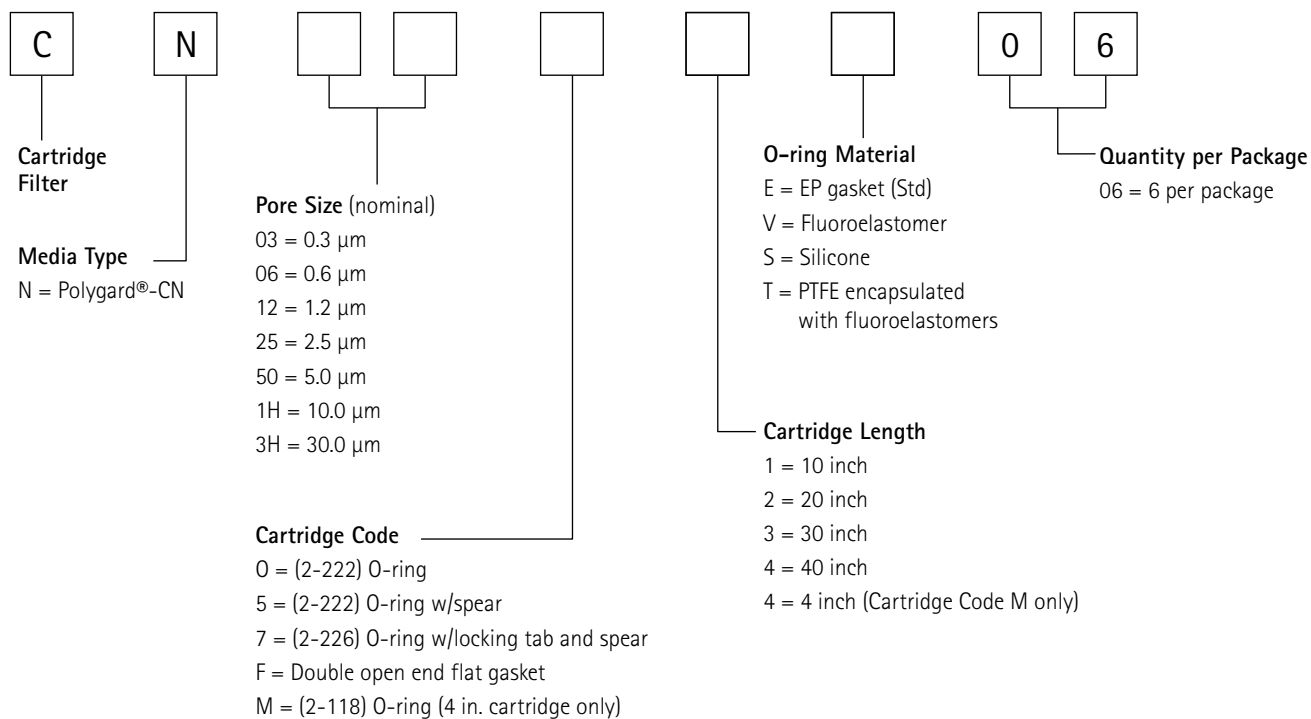

To Place an Order or Receive Technical Assistance

In the U.S. and Canada,
call toll-free 1-800-645-5476

For other countries across Europe and the world,
please visit: www.millipore.com/offices

For Technical Service, please visit:
www.millipore.com/techservice



www.millipore.com/offices